

ASSEMBLY INSTRUCTIONS

FORD TRANSIT 148'' CREW – HIGH ROOF

This document presents the detailed procedures for assembling Legend Fleet components and accessories.

Customers can make use these step-by-step procedures and easily assemble without major difficulty.



LEGEND

FLEET SOLUTIONS

519 688 1043
customercare@legendfleet.com

56957 HWY 3 WEST,
TILLSONBURG,
ON N4G 4G8.

Table of Contents

Wheel Well Cover.....	3
Parts and Hardware.....	3
Assembly Instructions.....	3
Floor.....	4
Parts and Hardware.....	4
Assembly Instructions.....	5
Floor Sills	8
Parts and Hardware.....	8
Assembly Instructions.....	8
Wall Liners.....	9
Parts and Hardware.....	9
Assembly Instructions.....	9
Ceiling Liners.....	12
Parts and Hardware.....	12
Assembly Instructions.....	12
Top Sills.....	14
Parts and Hardware.....	14
Assembly Instructions.....	14
Door Liners	16
Parts and Hardware.....	16
Assembly Instructions.....	17

Wheel Well Cover

Parts and Hardware

PARTS LIST	QTY
Driver Side's Wheel Cover	1
Passenger side's Wheel well cover	1
Push- in Rivet	4



DRIVER SIDE'S WHEEL WELL COVER



PASSENGER SIDE'S WHEEL WELL COVER



PUSH - IN RIVET

Assembly Instructions

Floor and Wall liner must be installed after the installation of Wheel well covers

Step 1: Place the **Driver side** and **Passenger side** wheel well covers in the vehicle, as shown below.

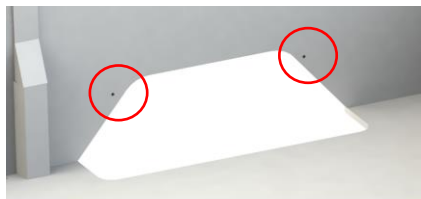

"Positioning of the Passenger side WWC"

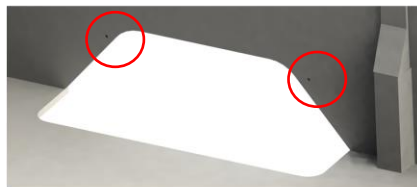

"Positioning of the Driver side WWC"

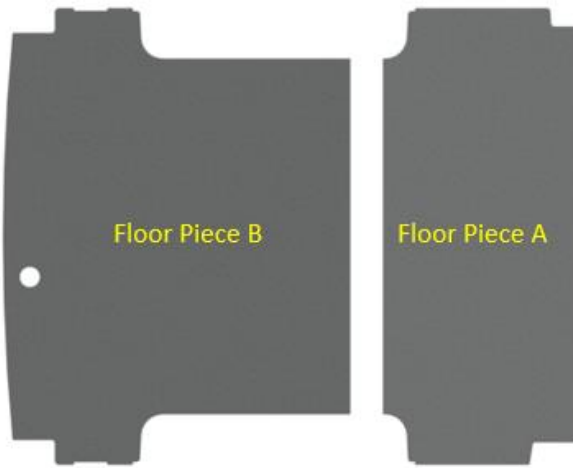

Figure 1

Floor

Parts and Hardware

PARTS LIST	QTY	PARTS LIST	QTY
Floor pieces	1 Each	Rear H Track (H2)	1
Glue Tube	1	VS Joiner Strip	1
Torx-head #8 (FS2-063-075)	8		



FLOOR PIECES

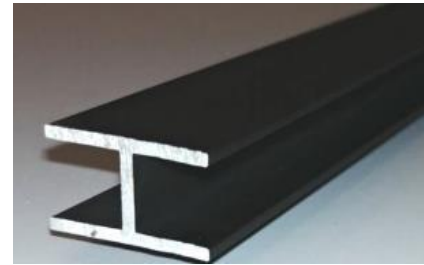

H-Track (53.125")



Glue Tube

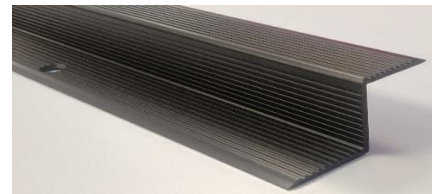

VS Joiner Strip (62.125")



Torx-head #8 (FS2-063-075)

Assembly Instructions

Remove the following items before floor installation:

- 1. Rear Doors Step area's OEM Plastic Trim**
- 2. D-Rings/ Tie-Downs**

Apply a thin line of glue in both the grooves of the Rail Joints, that is supplied with Legend's floor.

Step 1: Remove the OEM edging trim on the vinyl flooring of the vehicle as shown below.

Note: Do not remove it, if installing a rubber floor.

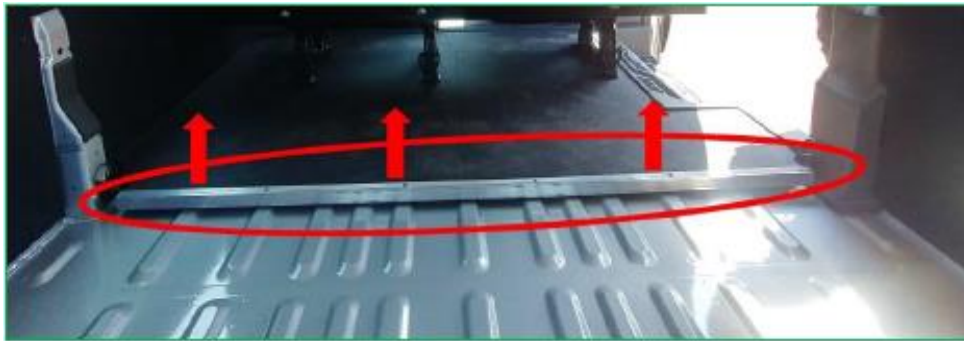

Figure 2

Step 2: Install Floor Piece A, as shown below.

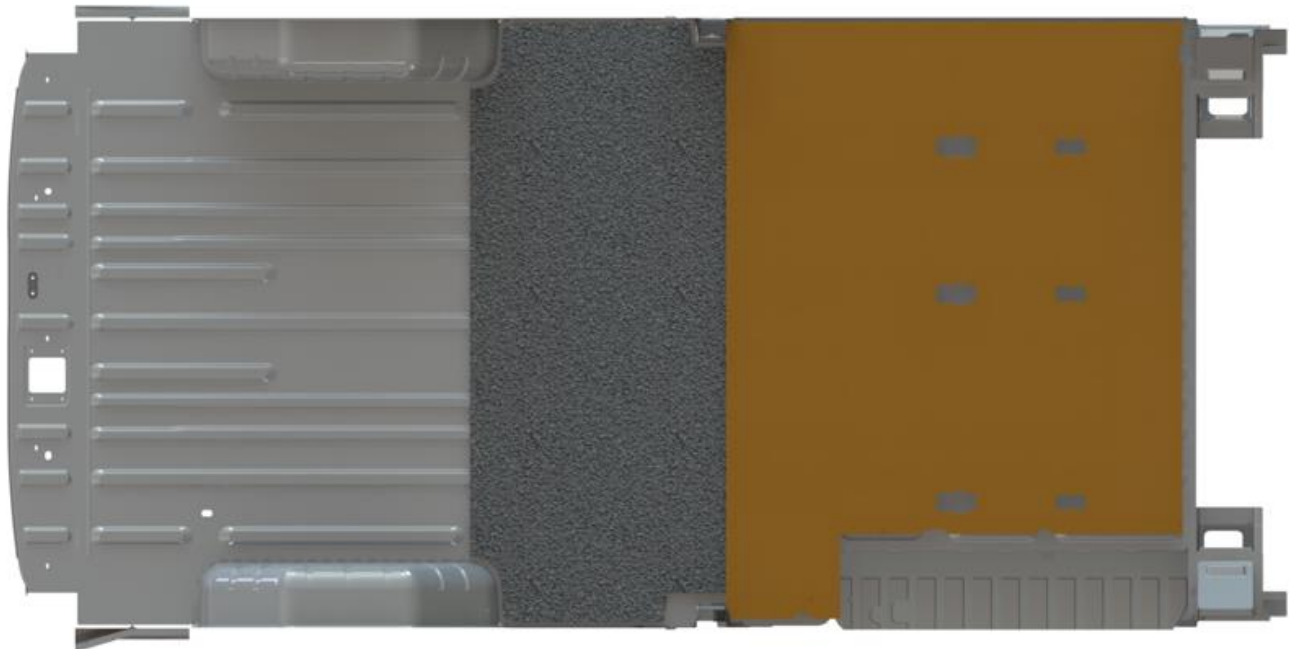

Figure 3 (Floor piece A in position)

Step 3: Install the Parts in the following order after installing Floor Piece A. as shown below.

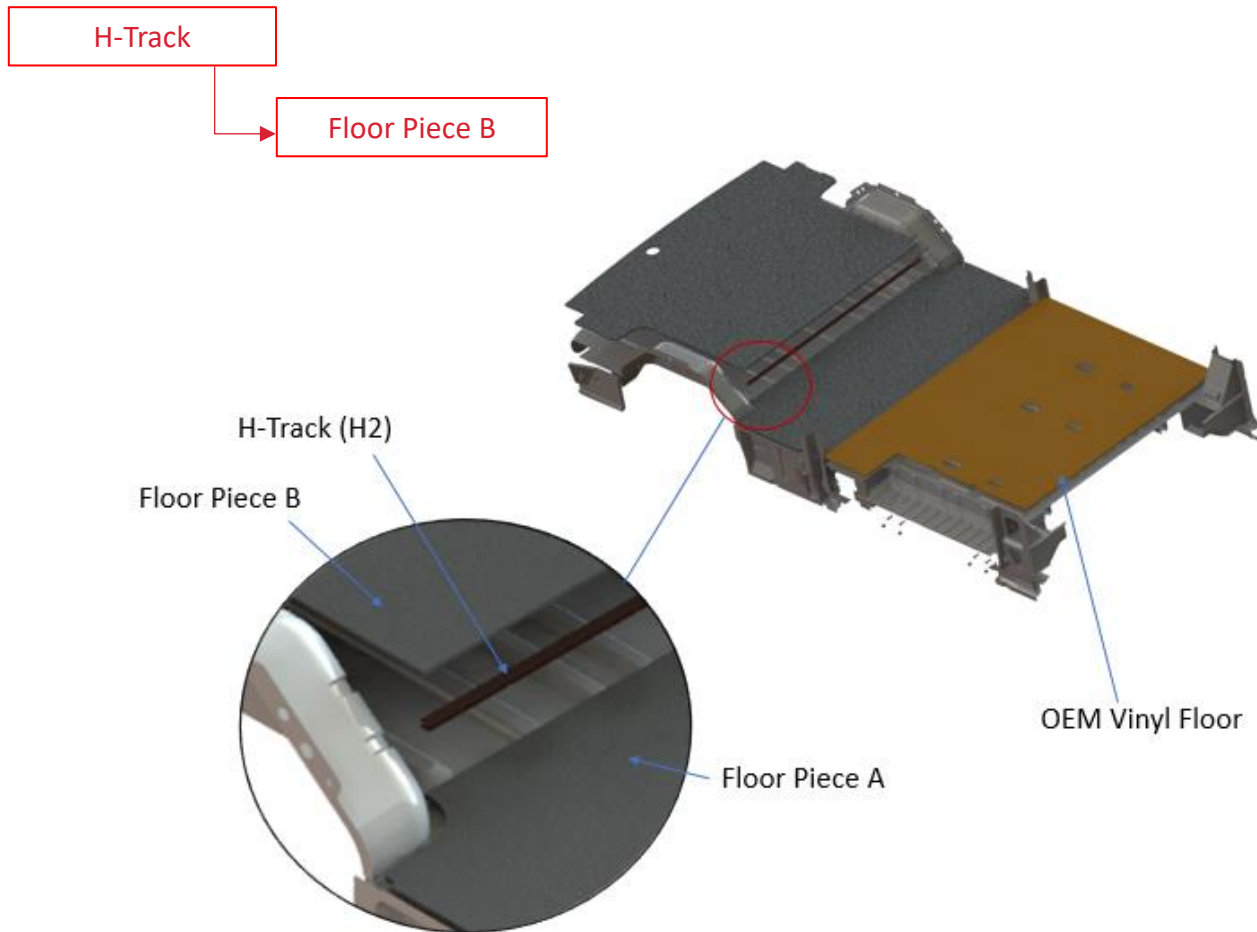

Figure 4 (Exploded view to install Rear H track and Floor piece B)

Step 4: Position the VS Joiner strip in at the edge of Floor Piece A as shown.

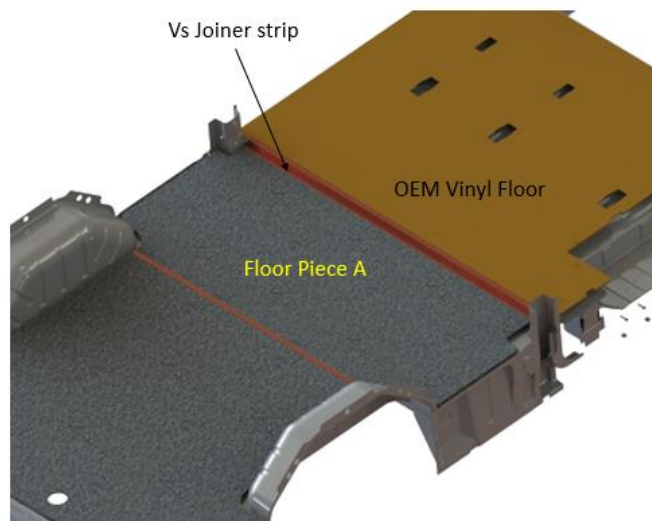

Figure 5

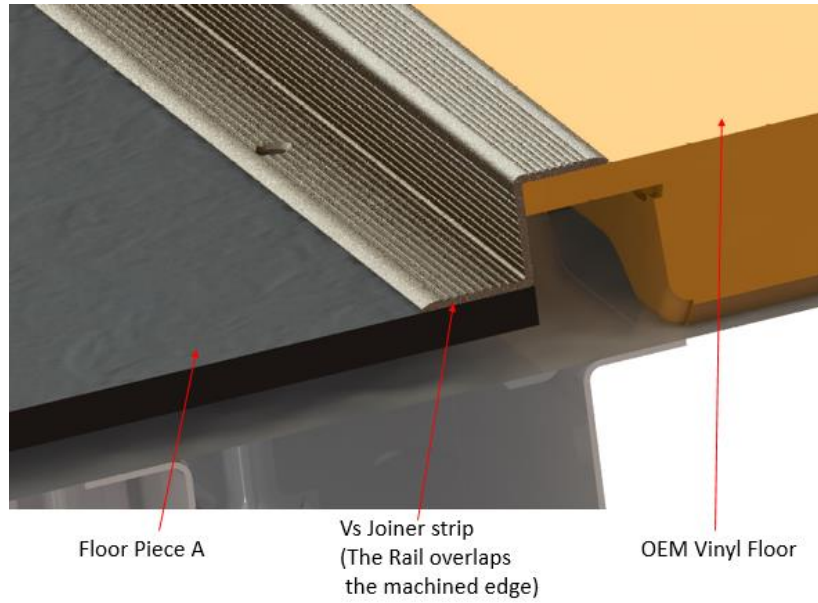

Figure 6

Step 5: Fasten the Transition Rail using the Torx-head screws as shown.

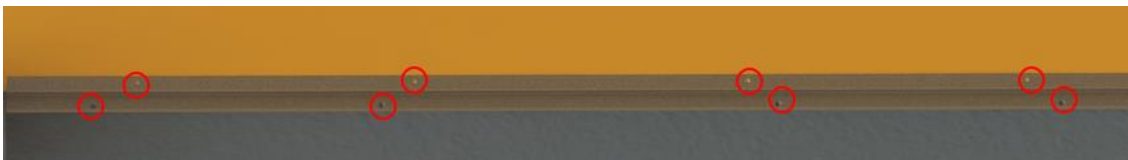

Figure 7

Step 6: Completing the installation of your Legend Floor piece.

Note: Reinstall the initially removed D-Rings/Tie-downs.

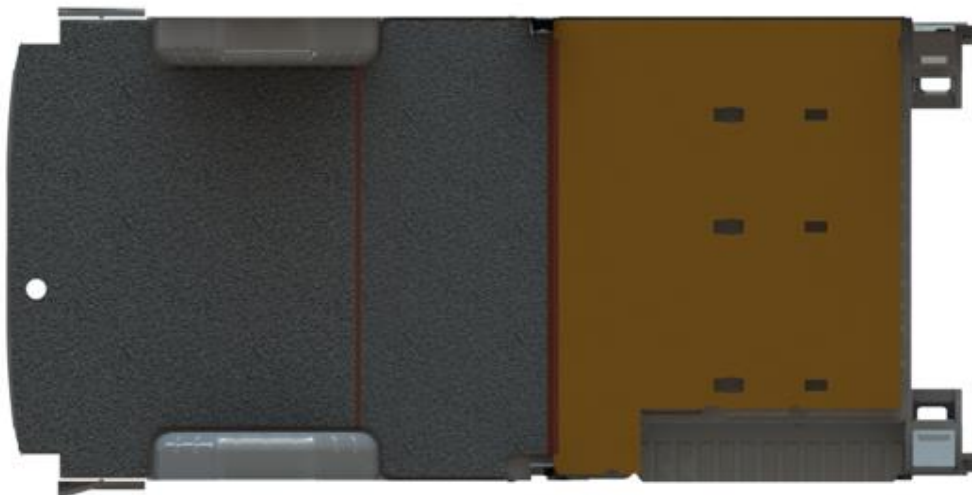

Figure 8

"Floor Installed" This view is from Inside of Van-Viewing from Top

Floor Sills

Parts and Hardware

PARTS LIST	QTY
Aluminium Rear Sill	1
Pan-head Screw	3

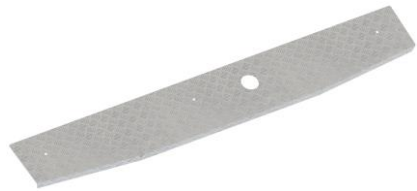

ALUMINIUM REAR SILL



Pan-head Screw

Assembly Instructions

Step 1: Position the Aluminium Rear Sill on Legend's Floor.

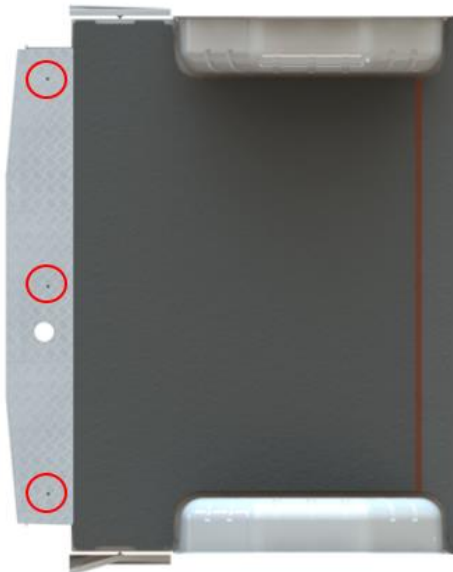

Figure 9

Wall Liners

Parts and Hardware

PARTS LIST	QTY	PARTS LIST	QTY
Driver Side Rear lower wall (D2A)	1	Driver Side Front lower wall (D1A)	1
driver Side Rear Upper WALL (D2B)	1	Passenger Side Wall (P1A)	1
Push-In Rivet	79		



DRIVER SIDE REAR LOWER WALL (D2A)



DRIVER SIDE FRONT LOWER WALL (D1A)



DRIVER SIDE REAR UPPER WALL (D2B)



PASSENGER SIDE WALL (P1A)



PUSH-IN RIVET

Assembly Instructions

If Legend's Wheel Well Covers are used, the Wall Liner will lay over the Top Flange of Wheel Well Cover.

Hole Diameter (\varnothing) = 0.40" = 

Step 1: Bring the (D1A) Liner into the vehicle and align the holes on the panel with the ones present on the vehicle's body.

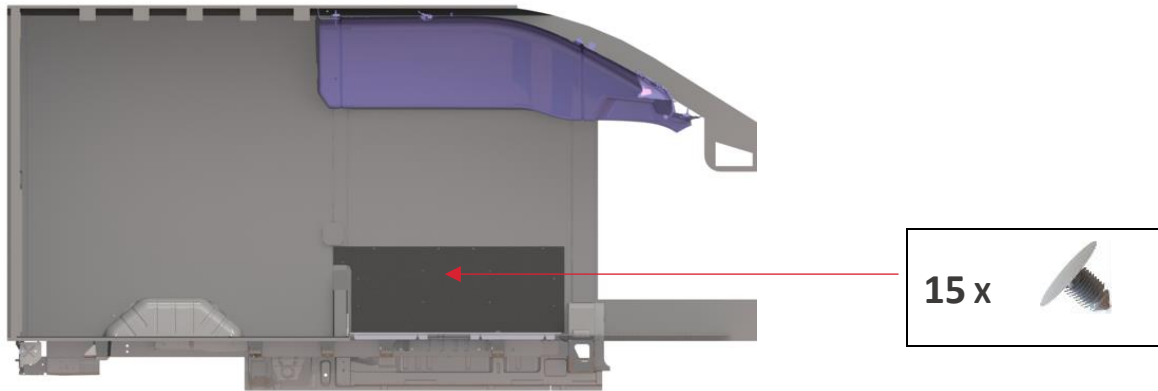
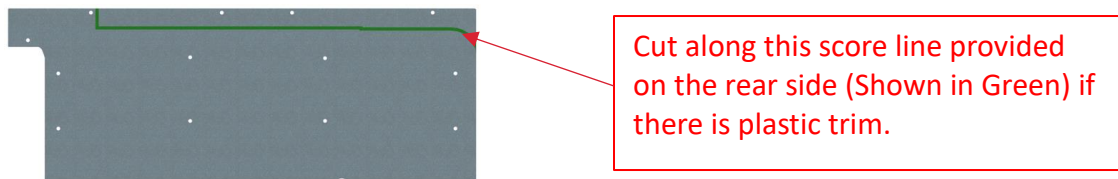

Figure 10



Step2: Bring the (D2A) Liner into the vehicle and align the holes on the panel with the ones present on the vehicle's body.

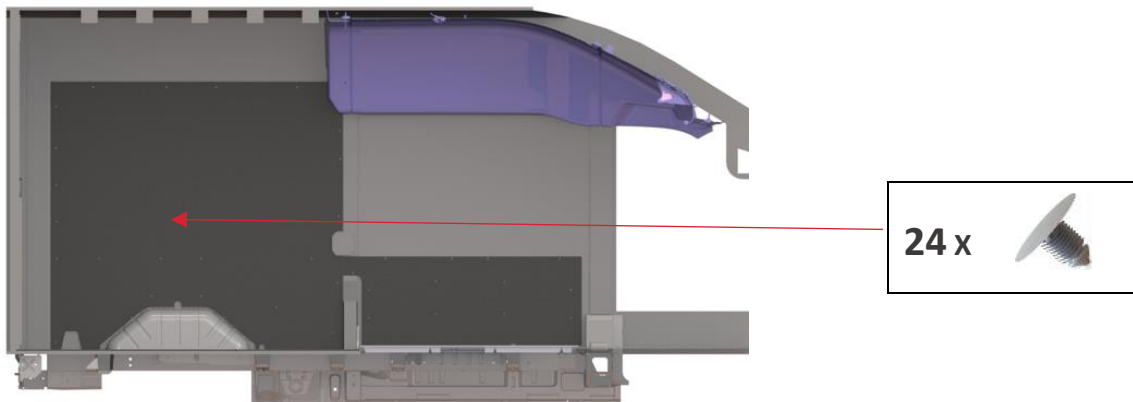
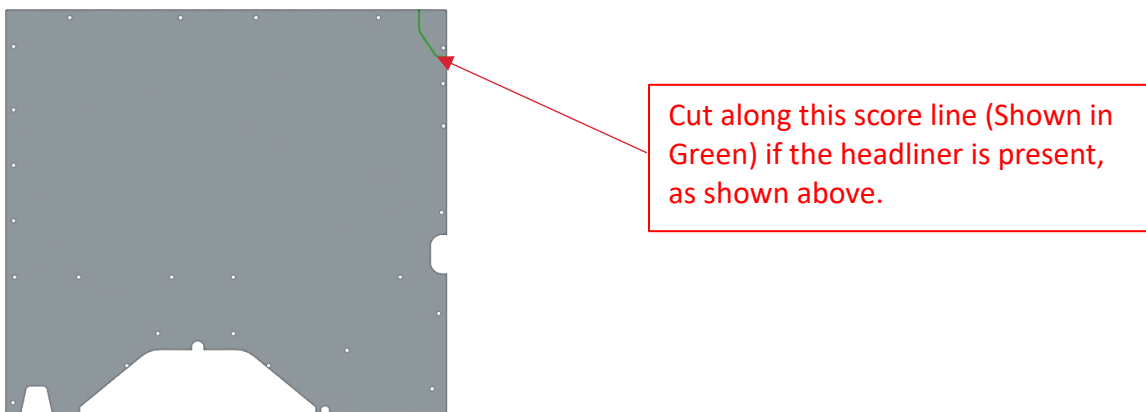

Figure 11



Step 3: Bring the (D2B) Liner into the vehicle and align the holes on the panel with the ones present on the vehicle's body.

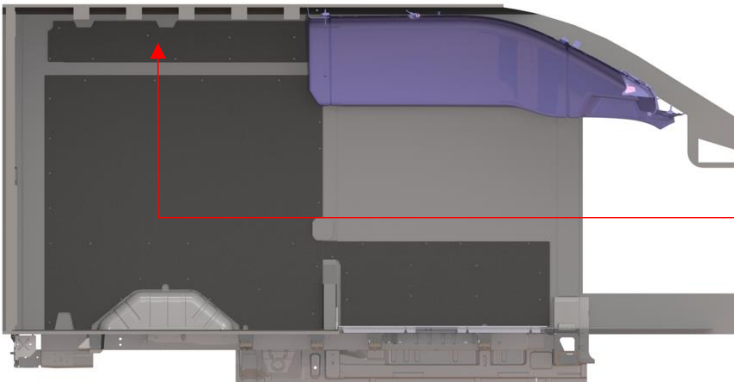

Figure 12

"Driver Side Rear & Front Wall Liner Installed" This is view from Inside of the Van- Viewing from Passenger Side



Cut along this score line (Shown in Green) if headliner is present, as shown above.

Step 4: Bring the (P1A) Liner into the vehicle and align the holes on the panel with the ones present on the vehicle's body.

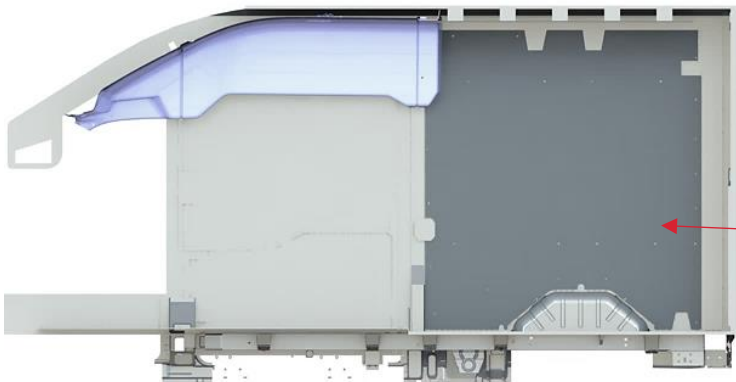
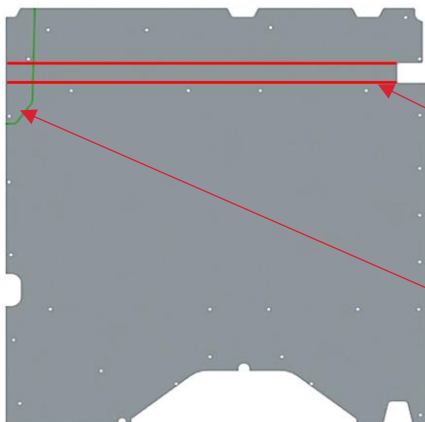

Figure 13

"Passenger Side Wall Installed" This is view from Inside of the Van- Viewing from Driver Side



Cut along this score line (Shown in red) if Electrical Conduit is present on Passenger Side.

Cut along this score line (Shown in Green) if headliner is present, as shown above.

Ceiling Liners

Parts and Hardware

PARTS LIST	QTY	PARTS LIST	QTY
Ceiling Piece	1	Self- Drilling Screw	2
Push-In Rivet	8	Screw CAP	2

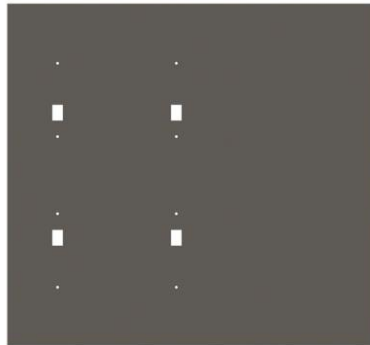

CEILING PIECE



PUSH-IN RIVET



SELF- DRILLING SCREW



SCREW CAP

Assembly Instructions

Follow the below instructions for score lines on Rear surface of Ceiling Panel

Cut along this score line (Shown in Red) to fit around the OEM Lights

Bend the Panel along this score line (Shown in Blue) to allow the ceiling to arch along the cross

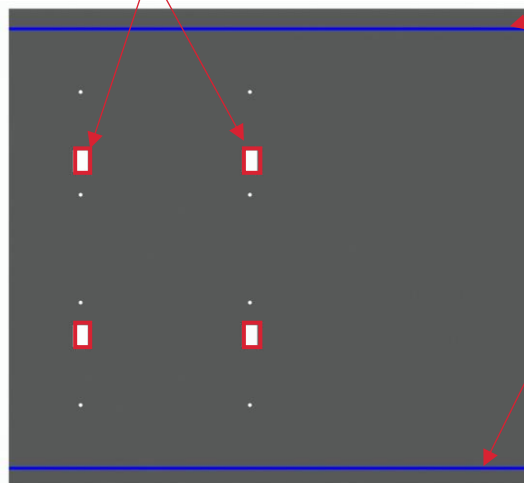

Step 1: Install Ceiling Piece as shown below.

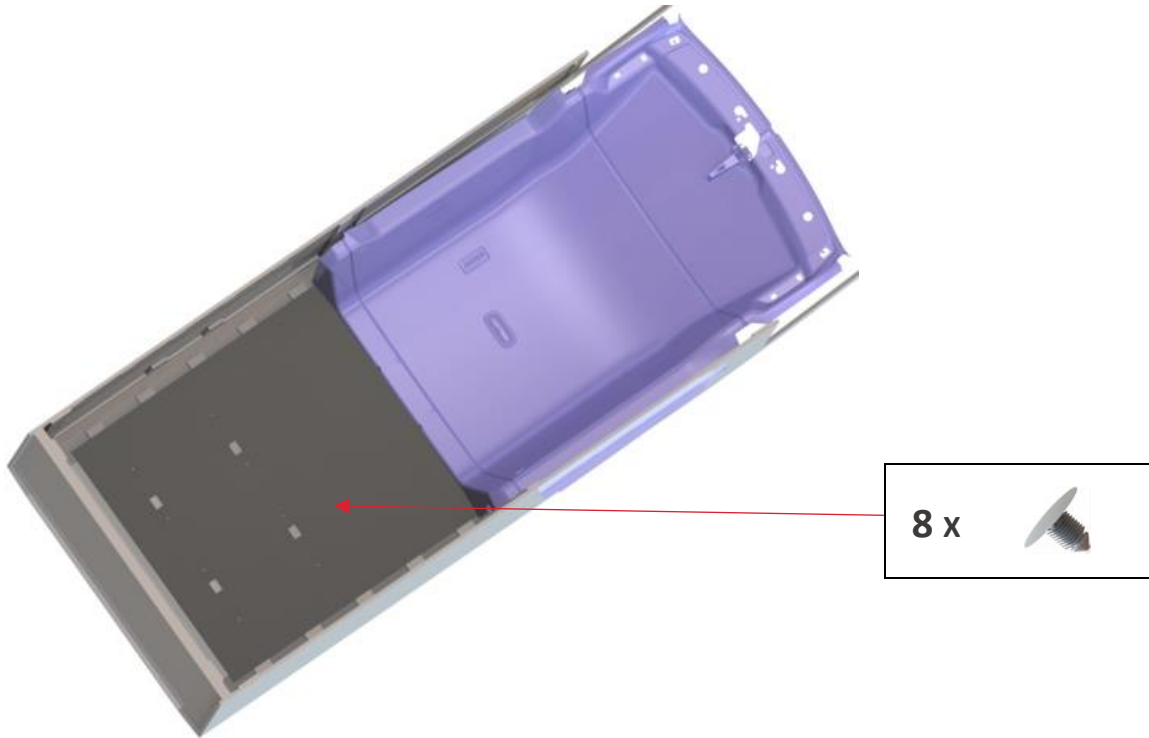

Figure 14

"Positioning and Fixing of the Ceiling Panel" This View is from Inside of the Van

Step 2: Fasten the front end of Legend Ceiling to the rear of headliner.

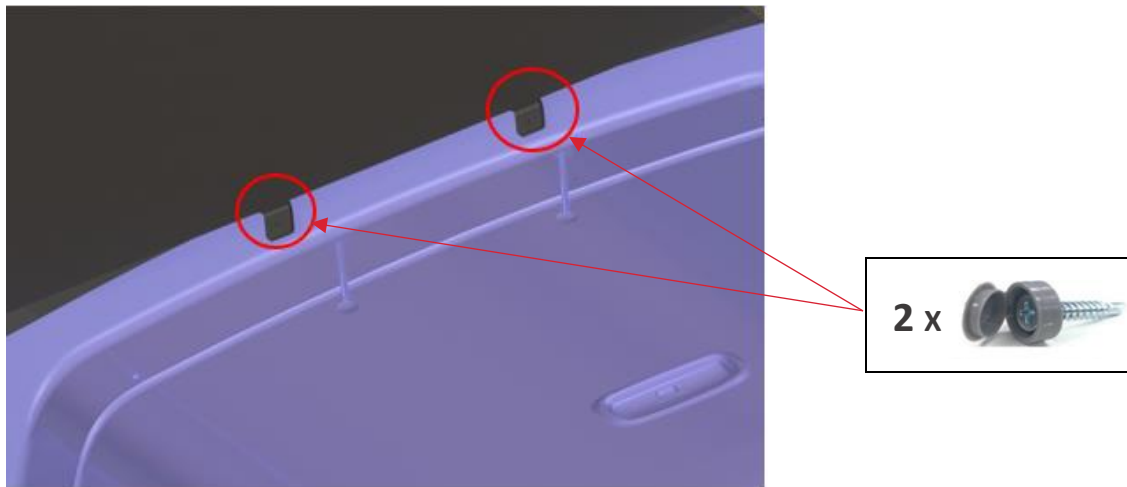

Figure 15

"Positioning and Fixing of the Ceiling Panel" This View is from Inside of the Van

Top Sills

Parts and Hardware

PARTS LIST	QTY
Side Sill	1 Each
Pan - Head Screw	30



SIDE SILL



PAN-HEAD SCREW

Assembly Instructions

Step 1: Bring the (DS1) Sill into the vehicle and align with the holes on the panel present on the vehicle's body.

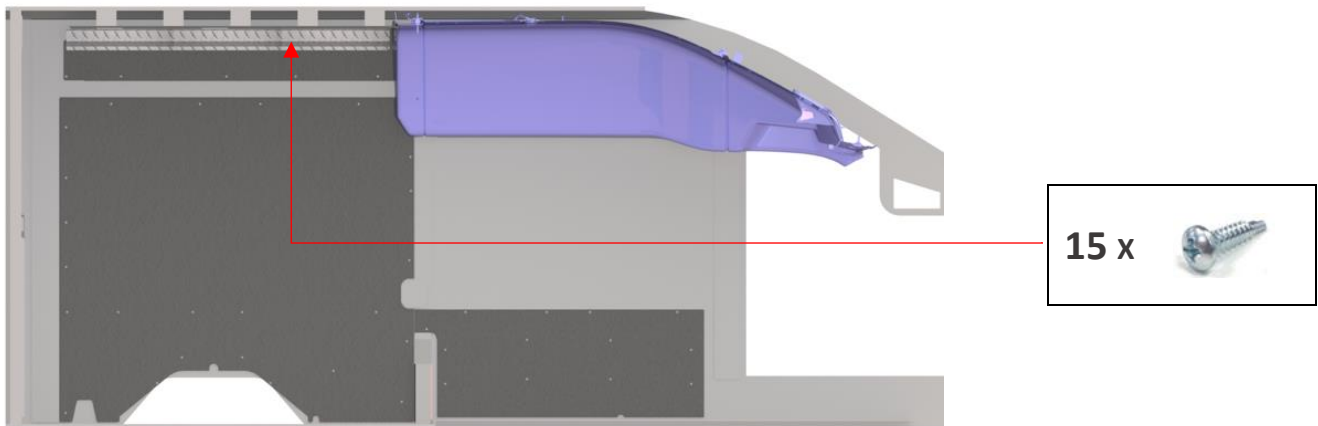

Figure 16
"Driver side Top Sills installed"

Step 2: Bring the (PS1) Sill into the vehicle and align with the holes on the panel present on the vehicle's body.

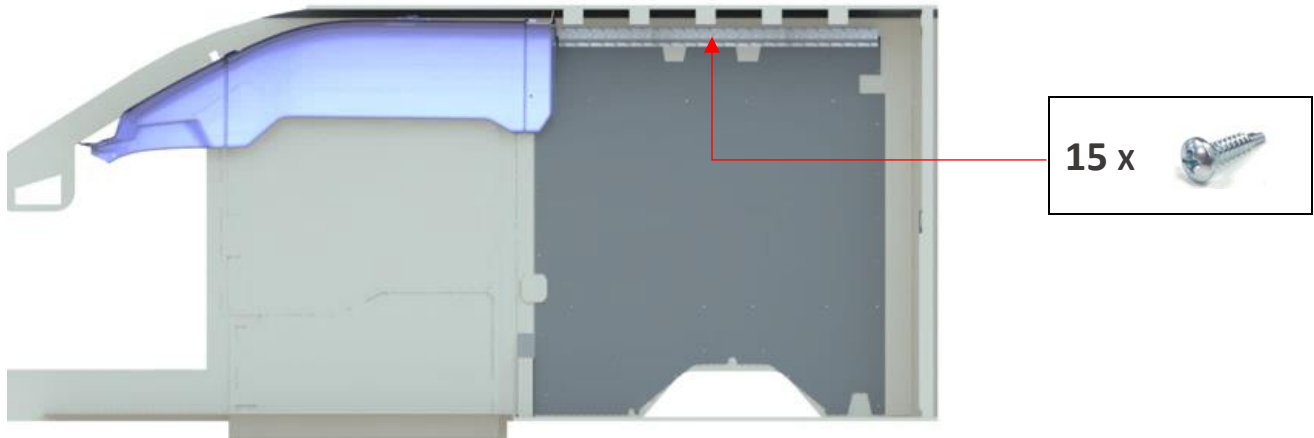
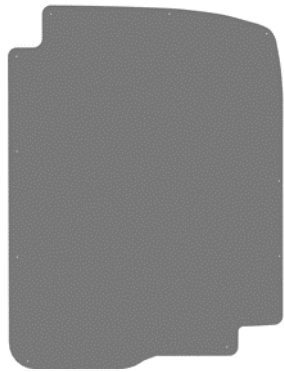

Figure 17
"Passenger side Top Sills installed"

Door Liners

Parts and Hardware

PARTS LIST	QTY	PARTS LIST	QTY
Driver Side Rear Door Liner	1	Screw Cap	20
Passenger Side Rear Door Liner	1	Self-Drilling Screw	20



DRIVER SIDE REAR DOOR LINER

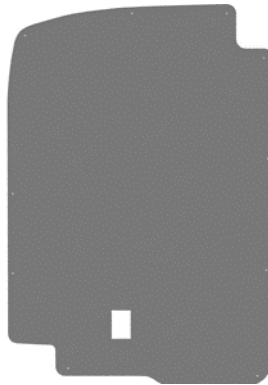

PASSENGER SIDE REAR DOOR LINER



SELF- DRILLING SCREW



SCREW CAP

Assembly Instructions

Van Doors MUST be in close Position When Installing Door Liners.

Hole Diameter (\varnothing) = 0.40" = 

Hole Diameter (\varnothing) = 0.20" = 

Step 1: Rear Door Assembly.

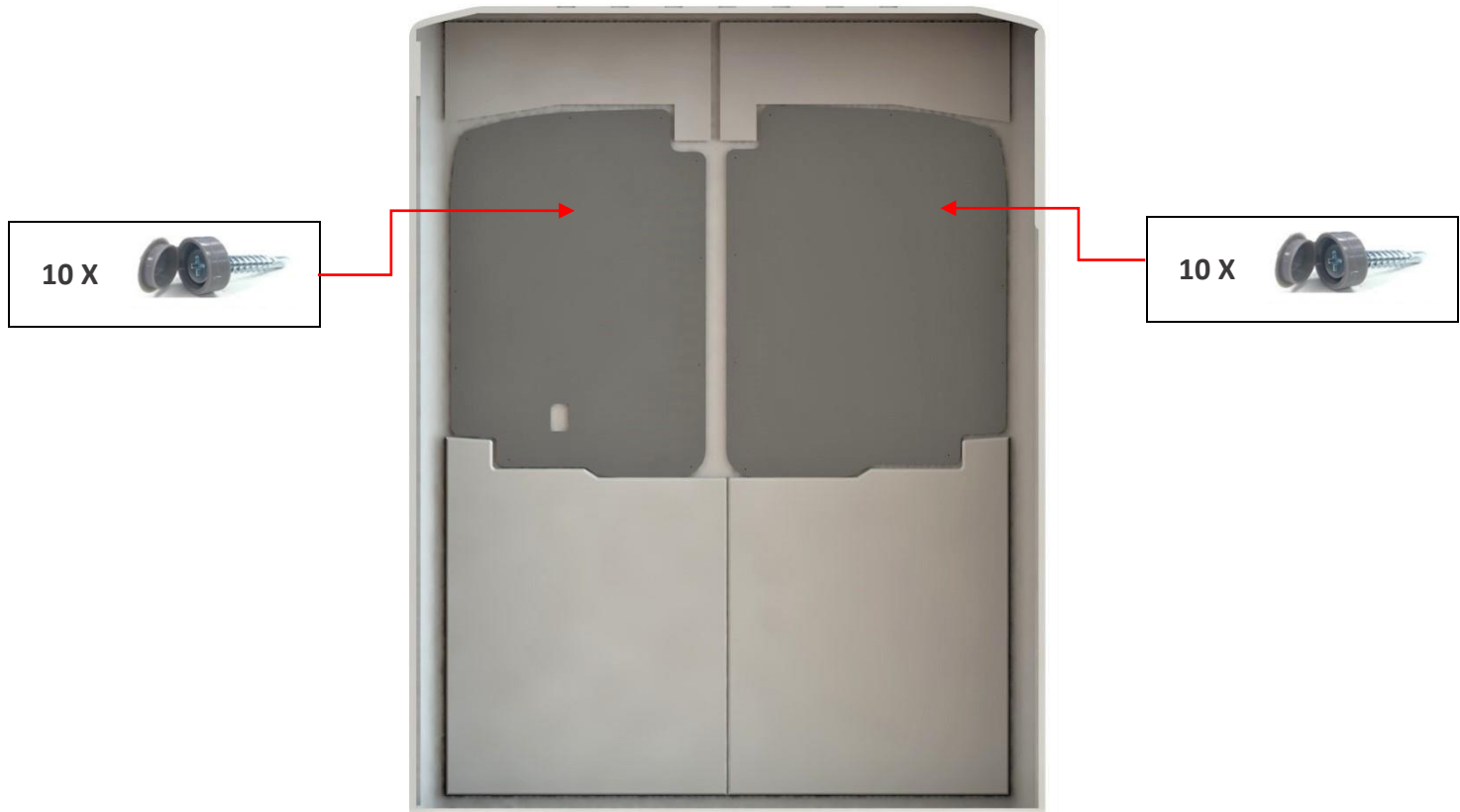

Figure 18
"Rear Door Liners Installed"

Step 3: Installation of your Legend Door Liners is now complete.